

All-in-one solar charge inverter

User Manual



Product models:

HFP4850S80-H

Important safety instructions

Please keep this manual for future use.

This manual contains all safety, installation and operating instructions for the HFP Series all-in-one solar charge inverter.

Please read all instructions and precautions in the manual carefully before installation and use.

- Non-safety voltage exists inside the all-in-one solar charge inverter. To avoid personal injury, users shall not disassemble the all-in-one solar charge inverter themselves. Contact our professional maintenance personnel if there is a need for repair.
- Do not place the all-in-one solar charge inverter within the reach of children.
- Do not install the all-in-one solar charge inverter in harsh environments such as moist, oily, flammable or explosive, or heavily dusty areas.
- The mains input and AC output are high voltage, so please do not touch the wiring terminals.
- The housing of the all-in-one solar charge inverter is hot when it is working. Do not touch it.
- Do not open the terminal protective cover when the all-in-one solar charge inverter is working.
- It is recommended to attach proper fuse or circuit breaker to the outside of the all-in-one solar charge inverter.
- Always disconnect the fuse or circuit breaker near the terminals of PV array, mains and battery before installing and adjusting the wiring of the all-in-one solar charge inverter.
- After installation, check that all wire connections are tight to avoid heat accumulation due to poor connection, which is dangerous.
- The all-in-one solar charge inverter is off-grid. It is necessary to confirm that it is the only input device for load, and it is forbidden to use it in parallel with other input AC power to avoid damage.

CONTENTS

1. GENERAL INFORMATION	4
1.1 PRODUCT OVERVIEW AND FEATURES	4
1.2 BASIC SYSTEM INTRODUCTION	5
1.3 APPEARANCE	6
1.4 DIMENSION DRAWING	7
2. INSTALLATION INSTRUCTIONS	8
2.1 INSTALLATION PRECAUTIONS	8
2.2 WIRING SPECIFICATIONS AND CIRCUIT BREAKER SELECTION	9
2.3 INSTALLATION AND WIRING	11
2.4 PARALLEL MACHINE WIRE CONNECTION	17
2.4.1 INTRODUCTION	17
2.4.2 PRECAUTIONS FOR CONNECTING THE PARALLEL CONNECTING LINES	17
2.4.3 SCHEMATIC DIAGRAM OF PARALLEL CONNECTION IN SINGLE PHASE	19
2.4.4 SCHEMATIC DIAGRAM OF PARALLEL CONNECTION IN SPILT PHASE	22
3. OPERATING MODES	28
3.1 CHARGING MODE	28
3.2 OUTPUT MODE	29
4. LCD SCREEN OPERATING INSTRUCTIONS	30
4.1 OPERATION AND DISPLAY PANEL	30
4.2 SETUP PARAMETERS DESCRIPTION	34
4.3 BATTERY TYPE PARAMETERS	40
5. OTHER FUNCTIONS	42
5.1 DRY CONTACT	42
5.2 RS485 COMMUNICATION PORT	42
5.3 USB COMMUNICATION PORT	42
5.4 PARALLEL COMMUNICATION FUNCTION (PARALLEL OPERATION ONLY)	43
5.5 CURRENT SHARING DETECTION FUNCTION (PARALLEL OPERATION ONLY)	43
6. PROTECTION	44
6.1 PROTECTIONS PROVIDED	44
6.2 FAULT CODE	46
6.3 HANDLING MEASURES FOR PART OF FAULTS	50
7. TROUBLESHOOTING	51
8. TECHNICAL PARAMETERS	52

1. General information

1.1 Product overview and features

HFP series is a new all-in-one hybrid solar charge inverter, which integrates solar energy storage & means charging energy storage and AC sine wave output. Thanks to DSP control and advanced control algorithm, it has high response speed, high reliability and high industrial standard. Four charging modes are optional, i.e. Only Solar, Mains Priority, Solar Priority and Mains & Solar hybrid charging; and two output modes are available, i.e. Inverter and Mains, to meet different application requirements.

The solar charging module applies the latest optimized MPPT technology to quickly track the maximum power point of the PV array in any environment and obtain the maximum energy of the solar panel in real time.

Through a state of the art control algorithm, the AC-DC charging module realizes fully digital voltage and current double closed loop control, with high control precision in a small volume. Wide AC voltage input range and complete input/output protections are designed for stable and reliable battery charging and protection.

Based on full-digital intelligent design, the DC-AC inverter module employs advanced SPWM technology and outputs pure sine wave to convert DC into AC. It is ideal for AC loads such as household appliances, power tools, industrial equipment, and electronic audio and video equipment. The product comes with a segment LCD design which allows real-time display of the operating data and status of the system. Comprehensive electronic protections keep the entire system safer and more stable.

Features:

1. Full digital voltage and current double closed loop control, advanced SPWM technology, output of pure sine wave.
2. Two output modes: mains bypass and inverter output; uninterrupted power supply.
3. Available in 4 charging modes: Only Solar, Mains Priority, Solar Priority and Mains & Solar hybrid charging.
4. Advanced MPPT technology with an efficiency of 99.9%.
5. Designed with a LCD screen and 3 LED indicators for dynamic display of system data and operating status.
6. ON/OFF rocker switch for AC output control.
7. Power saving mode available to reduce no-load loss.
8. Intelligent variable speed fan efficiently dissipate heat and extend system life.
9. Lithium battery activation by PV solar or mains, allowing access of lead-acid battery and lithium battery.
10. 360 ° all-around protection with a number of protection functions.
11. Complete protections, including short circuit protection, over voltage and under voltage protection, overload protection, reverse protection, etc.

1.2 Basic system introduction

The figure below shows the system application scenario of this product. A complete system consists of the following parts:

1. PV module: Convert light energy into DC power, and charge the battery through the all-in-one solar charge inverter, or directly invert into AC power to drive the load.

2. Mains or generator: Connected at the AC input, to power the load while charging the battery. If the mains or generator is not connected, the system can also operate normally, and the load is powered by the battery and PV module.

3. Battery: Provided to ensure normal power supply to the system loads when solar energy is insufficient and the Mains is not connected.

4. Household load: Allow connection of various household and office loads, including refrigerators, lamps, TVs, fans and air conditioners.

5. All-in-one solar charge inverter: The energy conversion unit of the whole system.

Specific system wiring method depends on the actual application scenario.

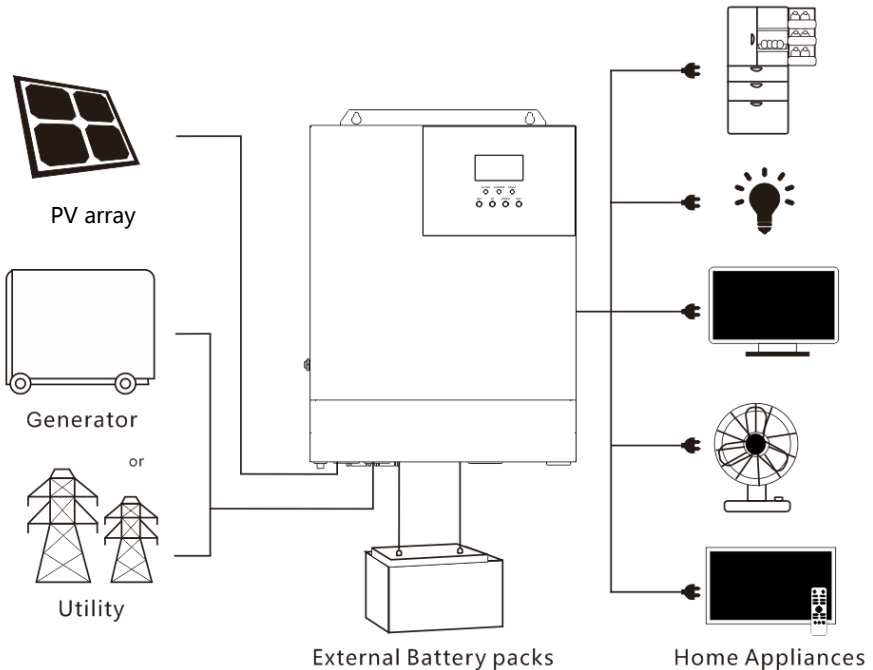

1.3 Appearance

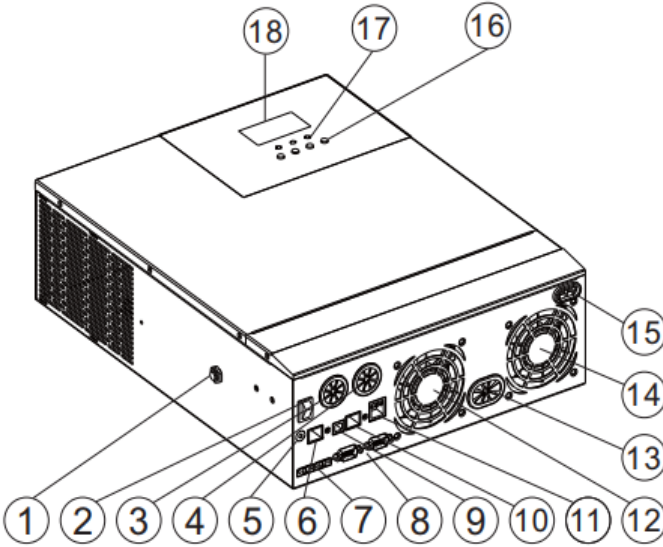

①	Overload protector	⑩	RS485-1 communication port
②	ON/OFF rocker switch	⑪	Dry contact port
③	AC input port	⑫	Cooling fan
④	AC output port	⑬	Battery port
⑤	Grounding screw hold	⑭	Cooling fan
⑥	RS485-2 communication port	⑮	PV port
⑦	Current sharing port (parallel module only)	⑯	Function key
⑧	Parallel communication port (parallel module only)	⑰	Indicator light
⑨	USB communication port	⑱	LCD screen

1.4 Dimension drawing

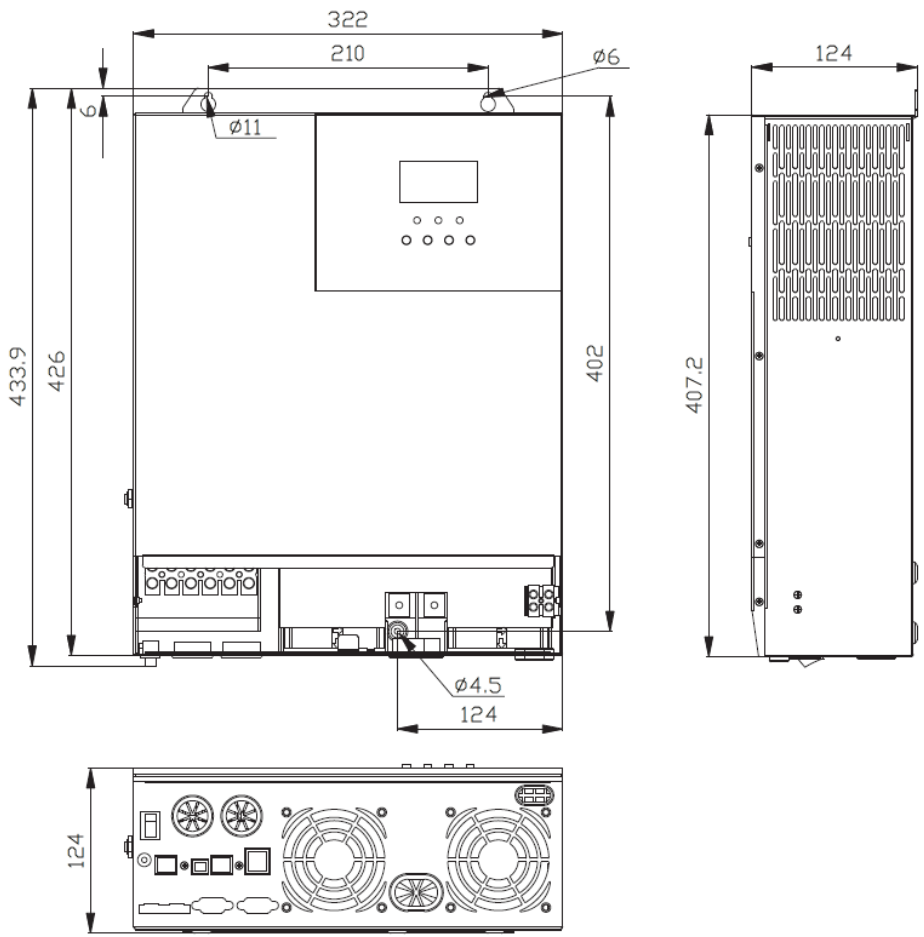

2. Installation instructions

2.1 Installation precautions

Please read this manual carefully prior to installation to familiarize yourself with the installation steps.

- Be very careful when installing the battery. Wear safety goggles when installing a lead-acid liquid battery. Once coming into contact with the battery acid, rinse with clean water timely.
- Do not place metal objects near the battery to prevent short-circuit of the battery.
- Acid gas may be generated when the battery is charged. So, please ensure good ventilation.
- When installing the cabinet, be sure to leave enough space around the all-in-one solar charge inverter for heat dissipation. Do not install the all-in-one solar charge inverter and lead-acid battery in the same cabinet to avoid corrosion by acid gas generated during battery operation.
- Only the battery that meets the requirements of the all-in-one unit can be charged.
- Poorly connected connections and corroded wires may cause great heat which will melt the wire insulation, burn the surrounding materials, and even cause fires. So, make sure the connectors have been tightened, and the wires are secured with ties to avoid looseness of connections caused by shaking of wires during mobile application.
- The system connection wires are selected according to a current density of not more than 5 A/mm².
- Avoid direct sunlight and rainwater infiltration for outdoor installation.
- Even after the power is turned off, there is still high voltage inside the unit. Do not open or touch the internal components, and avoid related operations until the capacitor completely discharges.
- Do not install the all-in-one solar charge inverter in harsh environments such as moist, oily, flammable or explosive, or heavily dusty areas.
- Polarity at the battery input end of this product shall not be reversed, otherwise it may damage the device or cause unpredictable danger.
- The mains input and AC output are high voltage, so please do not touch the wiring terminals.
- When the fan is working, do not touch it to prevent injury.
- Load equipment input power needs to confirm that this all-in-one solar charge inverter is the only input device, and it is forbidden to use in parallel with other input AC power to avoid damage. It is necessary to confirm that the solar charge inverter is the only input device for load equipment, and it is forbidden to use it in parallel with other input AC power to avoid damage.

2.2 Wiring specifications and circuit breaker selection

Wiring and installation must comply with national and local electrical codes.

Recommended PV array wiring specifications and circuit breaker selection: Since the output current of the PV array is affected by the type, connection method and illumination angle of the PV module, the minimum wire diameter of the PV array is calculated according to its short-circuit current; refer to the short-circuit current value in the PV module specification (the short-circuit current is constant when the PV modules are connected in series; the short-circuit current is the sum of the short-circuit currents of all PV modules connected in parallel); the short-circuit current of the PV array shall not exceed the maximum input current.

- **Refer to the table below for PV input wire diameter and switch:**

Models	Recommended PV wiring diameter	Maximum PV input current	Recommended circuit breaker type
HFP4850S80-H	6mm ² /10AWG	22A	2P—25A

Note: The voltage in series shall not exceed the maximum PV input open circuit voltage.

- **Refer to the table below for recommended AC input wire diameter and switch:**

Models	Recommended AC input wiring diameter	Maximum bypass input current	Recommended circuit breaker type
HFP4850S80-H	10mm ² /7AWG	40A	2P—40A

Note: There is already an appropriate circuit breaker at the Mains input wiring terminal, so it is not necessary to add one more.

➤ **Recommended battery input wire diameter and switch selection**

Models	Recommended battery wiring diameter	Rated battery discharge	Maximum charge current	Recommended circuit breaker type
HFP4850S80-H	30mm ² /2AWG	125A	80A	2P—160A

➤ **Recommended AC output wiring specifications and circuit breaker selection**

Models	Recommended AC output wiring	Rated inverter AC output current	Maximum bypass output current	Recommended circuit breaker type
HFP4850S80-H	10mm ² /7AW	22A	40A	2P—40A

Note: The wiring diameter is for reference only. If the distance between the PV array and the all-in-one solar charge inverter or the distance between the all-in-one solar charge inverter and the battery is relatively long, using a thicker wire can reduce the voltage drop to improve system performance.

Note: The above are only recommended wiring diameter and circuit breaker. Please select the appropriate wiring diameter and circuit breaker according to actual situations.

2.3 Installation and wiring

Installation steps: :

Step 1: Determine the installation position and the space for heat dissipation. Determine the installation position of the all-in-one solar charge inverter, such as wall surface; when installing the all-in-one solar charge inverter, ensure that there is enough air flowing through the heat sink, and space of at least 200mm to the left and right air outlets of the inverter shall be left to ensure natural convection heat dissipation. Refer to the installation diagram of the whole machine as above.



Warning: Danger of explosion! Never install the all-in-one solar charge inverter and lead-acid battery in the same confined space! Also do not install in a confined place where battery gas may collect.

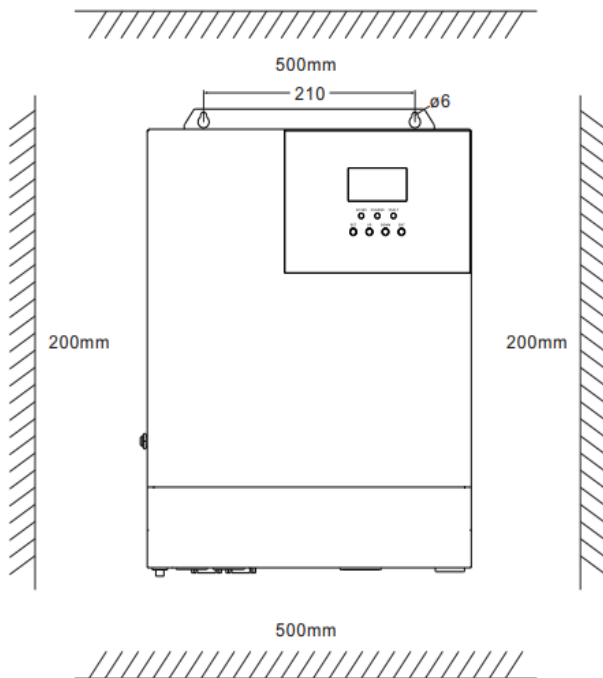

Step 2: Remove the terminal cover

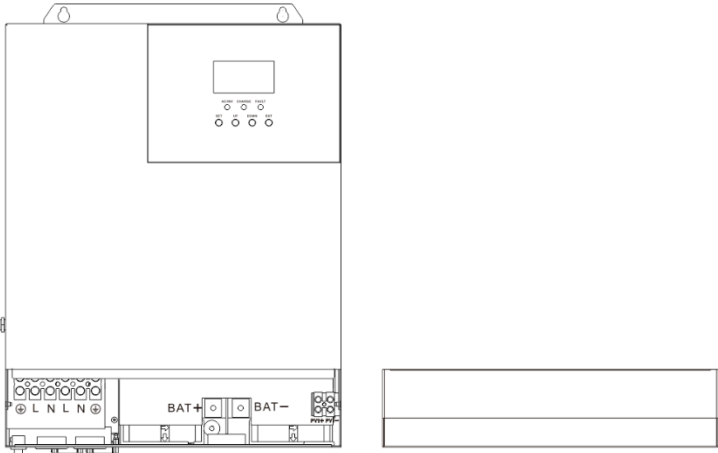

Step3: Wiring

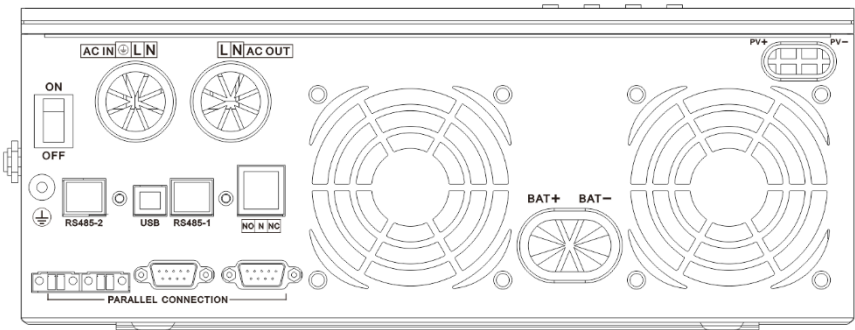

AC input / output wiring method:

- ① Prior to AC input/output wiring, opening the external circuit breaker and confirm that the wire used is thick enough. Please refer to Section 2.2 “Wiring Specifications and Circuit Breaker Selection” ;
- ② Properly connect the AC input wire according to the wire sequence and terminal position shown in the figure below. Please connect the ground wire first, and then the live wire and the neutral wire;

⊕ : Ground

L : Live

N : Neutral

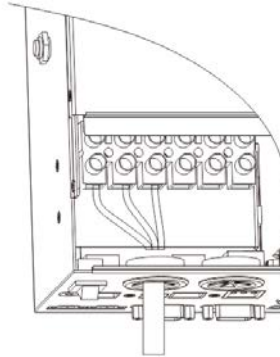
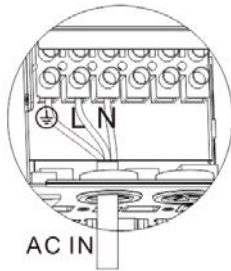

- ③ Properly connect the AC output wire according to the wire sequence and terminal position shown in the figure below. Please connect the ground wire first, and then the live wire and the neutral wire. The ground wire is connected to the grounding screw hole on the cabinet through the O-type terminal.

⊕ : Ground

L : Live

N : Neutral

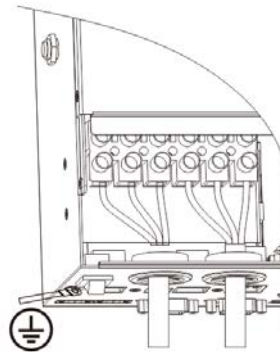
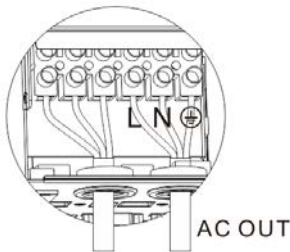

Note: The grounding wire shall be as thick as possible (cross-sectional area is not less than 4mm²). The grounding point shall be as close as possible to the all-in-one solar charge inverter. The shorter the grounding wire, the better.

PV input wiring method:

- ① Prior to wiring, disconnect the external circuit breaker and confirm that the wire used is thick enough. Please refer to Section 2.2 "Wiring Specifications and Circuit Breaker Selection" ;
- ② Properly connect the PV input wire according to the wire sequence and terminal position shown in the figure below.

PV+: PV input positive pole

PV-: PV input negative pole

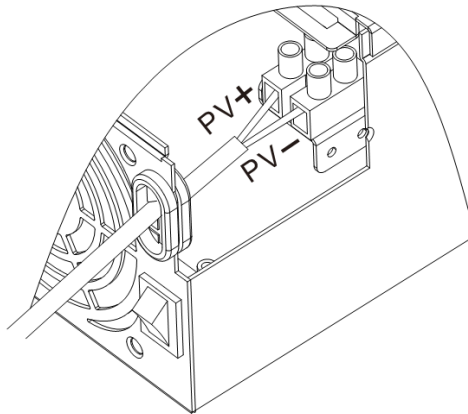

BAT wiring method:

- ① Prior to wiring, disconnect the external circuit breaker and confirm that the wire used is thick enough. Please refer to Section 2.2 "Wiring Specifications and Circuit Breaker Selection" . The BAT wire needs to be connected to the machine through the O-type terminal. The O-type terminal with an inner diameter of 5 mm is recommended. The O-type terminal shall firmly press the BAT wire to prevent excessive heat generation caused by excessive contact resistance;
- ② Properly connect the BAT wire according to the wire sequence and terminal position shown in the figure below.

BAT+: Battery positive electrode

BAT-: Battery negative electrode

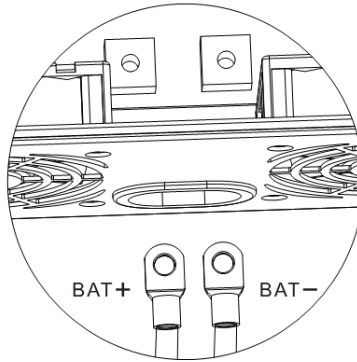

Warnings:

- ① Mains input, AC output and PV array will generate high voltage. So, before wiring, be sure to opening the circuit breaker or fuse;
- ② Be very careful during wiring; do not close the circuit breaker or fuse during wiring, and ensure that the “+” and “-” pole leads of each component are connected properly; a circuit breaker must be installed at the battery terminal. Refer to Section 2.2 “Wiring Specifications and Circuit Breaker Selection” to select a right circuit breaker. Before wiring, be sure to disconnect the circuit breaker to prevent strong electric sparks and avoid battery short circuit; if the all-in-one solar charge inverter is used in an area with frequent lightning, it is recommended to install an external lightning arrester at the PV input terminal.

Step 4: Check if the wiring is correct and firm. In particular, check if the battery polarity is reversed, if the PV input polarity is reversed and if the AC input is properly connected.

Step 5: Install the terminals cover.

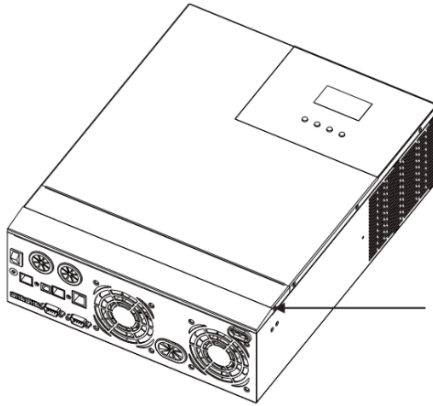

Step 6: Turn on the all-in-one solar charge inverter

First, close the circuit breaker at the battery terminal, and then turn the rocker switch on the left side of the machine to the "ON" state. The "AC/INV" indicator flashing indicates that the inverter is working normally. Close the circuit breakers of the PV array and the Mains. Finally, turn on AC loads one by one as the AC output is normal to avoid a protection action caused by a large momentary shock due to simultaneous turning on the loads simultaneously. Now, the machine goes into a normal operation according to the set mode.

Note: If power is supplied to different AC loads, it is recommended to first turn on the load with a large surge current. After the load is stable, turn on the load with a small surge current.

Note: If the all-in-one solar charge inverter does not work properly or the **LCD** or indicator is abnormal, refer to Chapter 6 to handle the exceptions.

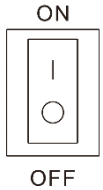

2.4 Parallel machine wire connection

2.4.1 Introduction

1. Up to six units connected in parallel.
2. When using the parallel operation function, the following connecting lines (package accessories) shall be firmly and reliably connected:

DB15 Parallel communication line*1:

Current sharing detection line*1:

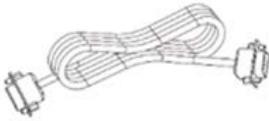

2.4.2 Precautions for connecting the parallel connecting lines

Warning: 

1. **Battery wiring:**

Parallel connection in single or three phase: Ensure that all all-in-one solar charger inverters are connected to the same battery, with BAT + connected to BAT + , BAT - connected to BAT - , and that the connection is correct with the same wiring length and line diameter before power on and start-up, so as to avoid the abnormal operation of parallel system output caused by wrong connection.

2. **AC OUT wiring:**

Parallel connection in single phase: Ensure L-to-L, N-to-N and PE-to-PE connection for all all-in-one solar charger inverters, and that the connection is correct with the same wiring length and line diameter before power on and start-up, so as to avoid the abnormal operation of parallel system output caused by wrong connection. For specific wiring, please refer to 2.4.3 Wiring Diagram

Parallel connection in three phase: Ensure N-to-N and PE-to-PE connection for all all-in-one solar charger inverters. The **L** lines of all inverters connected to the same phase need to be connected together. But **L** lines of different phases cannot be joined together. Other

connection precautions are the same as parallel connection in single phase. For specific wiring, please refer to 2.4.4 Wiring Diagram

3. **AC IN wiring:**

Parallel connection in single phase: Ensure L-to-L, N-to-N and PE-to-PE connection for all all-in-one solar charger inverters, and that the connection is correct with the same wiring length and line diameter before power on and start-up, so as to avoid the abnormal operation of parallel system output caused by wrong connection. Meanwhile, it is not allowed to have multiple different AC source inputs to avoid damage to the external equipment of the inverter. The consistency and uniqueness of AC source input shall be ensured. For specific wiring, please refer to 2.4.3 Wiring Diagram.

Parallel connection in three phase: Ensure N-to-N and PE-to-PE connection for all all-in-one solar charger inverters. The **L** lines of all inverters connected to the same phase need to be connected together. But **L** lines of different phases cannot be joined together. Other connection precautions are the same as parallel connection in single phase. For specific wiring, please refer to 2.4.4 Wiring Diagram.

4. **Wiring of parallel communication line:**

Parallel connection in single or three phase: Our company's parallel communication line is a DB15 standard computer cable with shielding function. Ensure the "one-in-one-out" rule when connecting each inverter, that is, connect the male connector (out) of this inverter with the female connector (in) of the inverter to be paralleled. Do not connect the male connector of the inverter to its female connector. In addition, make sure to tighten the parallel communication line of each inverter with self-contained end screws of DB15 to avoid the abnormal operation or damage of the system output caused by the falling off or poor contact of the parallel communication line.

5. **Wiring of current sharing detection line:**

Parallel connection in single phase: Our company's current sharing detection line is a twisted connection line. Ensure the "one-in-one-out" rule when connecting each inverter, that is, connect the current sharing line of the inverter with the current sharing green port of the

inverter to be paralleled (choose one port from the two, and there is no mandatory sequence requirement). The current sharing ports of the inverter cannot be connected to each other. In addition, make sure that the red and black current sharing connection lines of each inverter are not manually exchanged, and make sure to tighten the lines with self-contained screws to avoid the abnormal operation or damage of the system output caused by abnormal parallel current sharing detection. For specific wiring, please refer to 2.4.3 Wiring Diagram.

Parallel connection in three phase: The current sharing detection lines of all inverters connected to the same phase need to be connected together. But the current sharing detection lines of different phases cannot be joined together. Other connection precautions are the same as parallel connection in single phase. For specific wiring, please refer to 2.4.4 Wiring Diagram.

6. Before or after connecting the system, please carefully refer to the following system wiring diagram to ensure that all wiring is correct and reliable before power on.
7. After the system is wired, powered on and in normal operation, if a new inverter needs to be connected, make sure to disconnect the battery input, PV input, AC input and AC output, and that all all-in-one solar charger inverters are powered off before reconnecting into the system.

2.4.3 Schematic diagram of parallel connection in single phase

1. The parallel communication line and current sharing detection line of the all-in-one solar charger inverter need to be locked with screws after connecting. The schematic diagram is as follows:

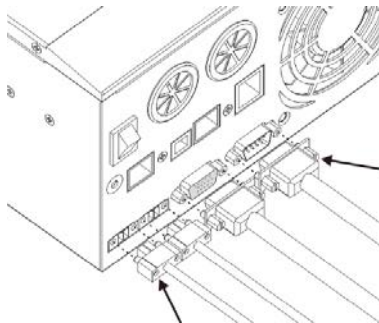

2. In case of parallel operation with multiple inverters, the schematic diagram of parallel connection is as follows:
 - a) **Two all-in-one solar charger inverters of the system connected in parallel:**

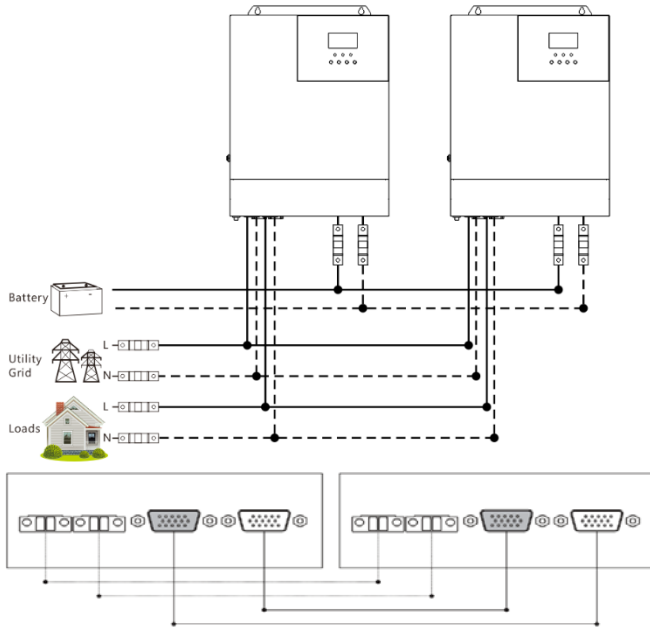

b) Three all-in-one solar charge inverters of the system connected in parallel:

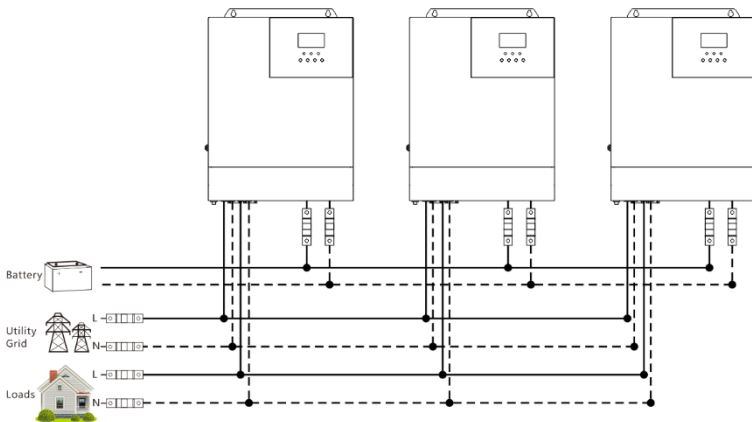

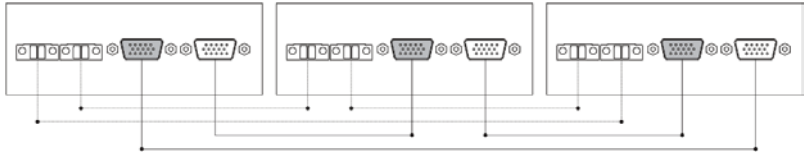

c) Four all-in-one solar charge inverters of the system connected in parallel:

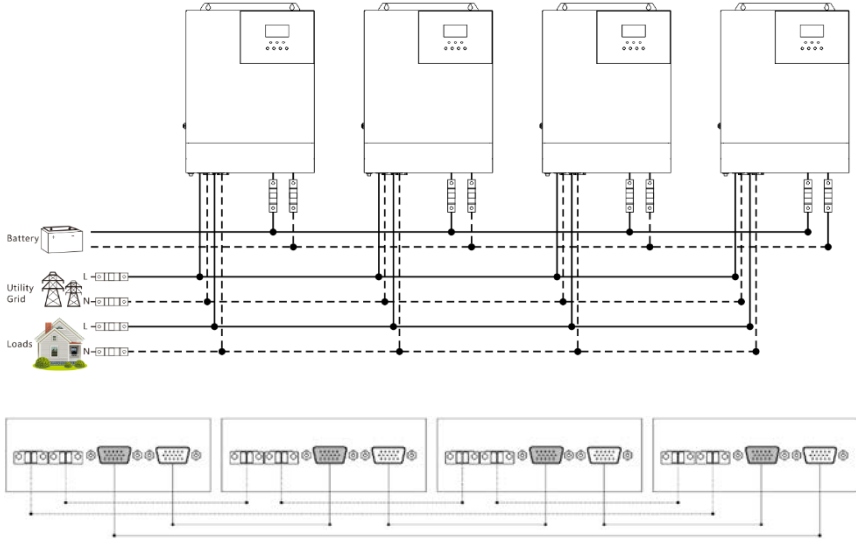

d) Five all-in-one solar charge inverters of the system connected in parallel:

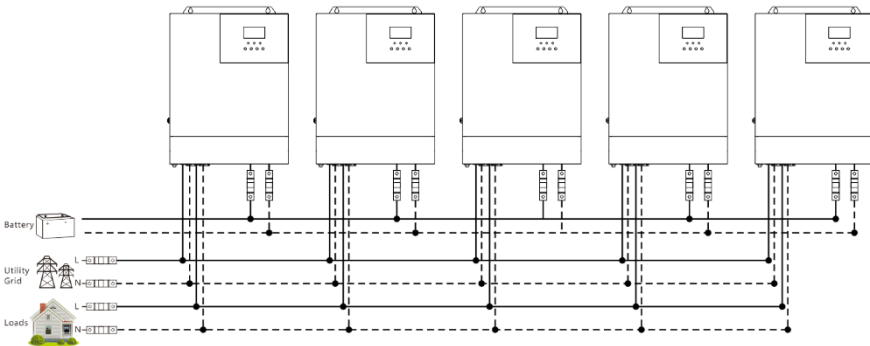

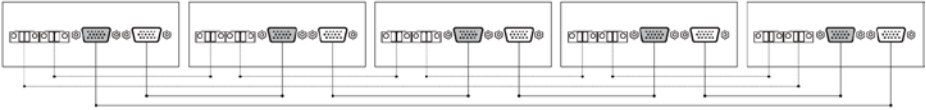

e) Six all-in-one solar charger inverters of the system connected in parallel:

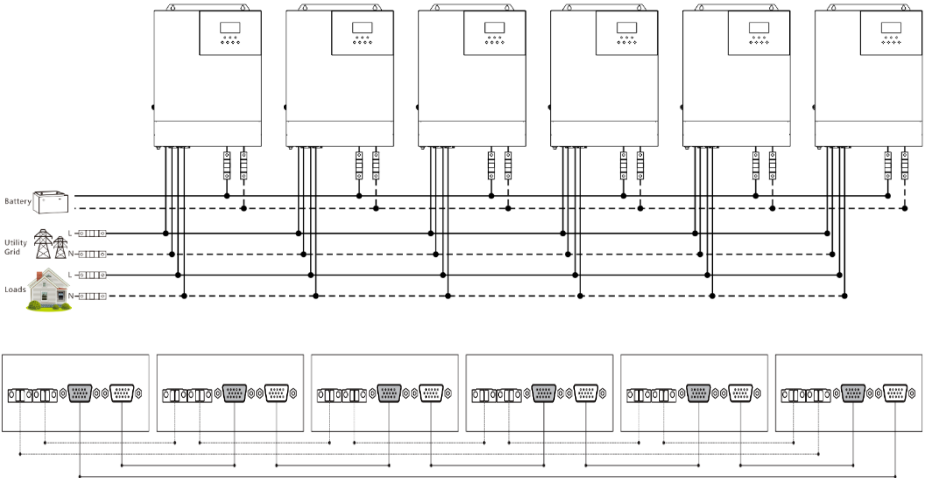

2.4.4 Schematic diagram of parallel connection in three phase

1. The parallel communication line and current sharing detection line of the all-in-one solar charge inverter need to be locked with screws after connecting. The schematic diagram is as follows:

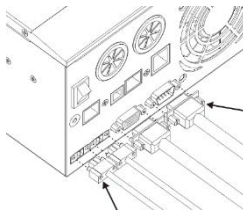

2. In case of parallel operation with multiple inverters, the schematic diagram of parallel connection is as follows:

Parallel Operation in three phase :

- a) Three all-in-one solar charge inverters of the system connected in three phase:
1+1+1 system:

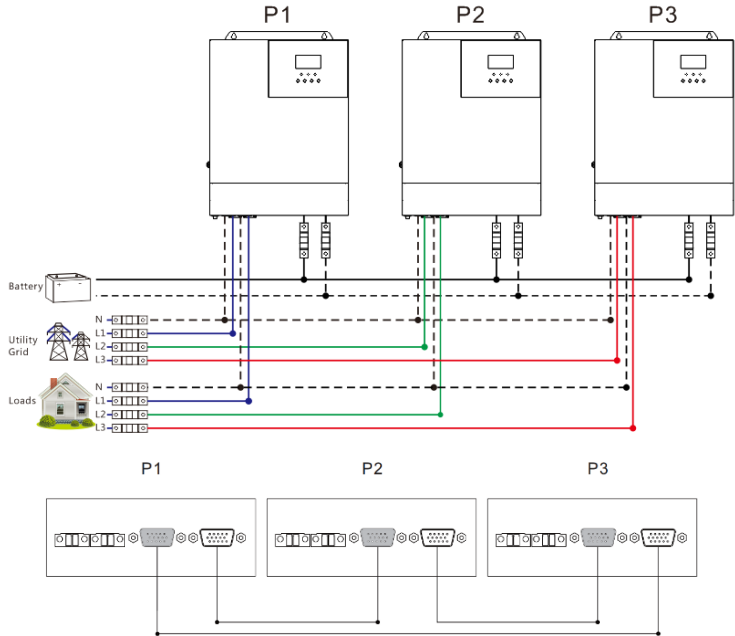

- b) Four all-in-one solar charge inverters of the system connected in three phase:
2+1+1 system:

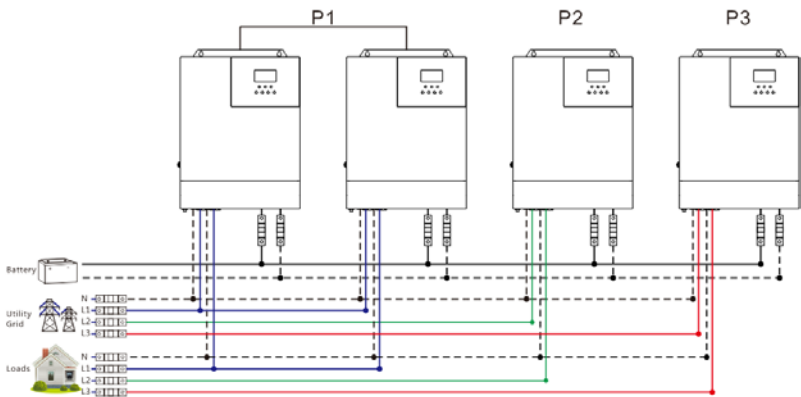

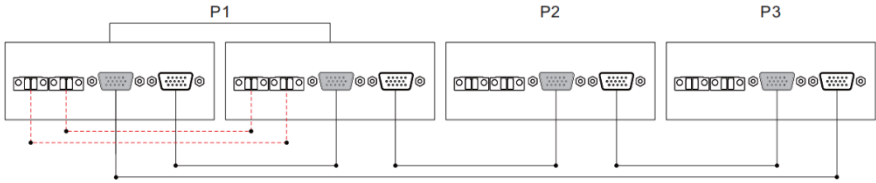

c) **Five all-in-one solar charge inverters of the system connected in three phase:
3+1+1 system:**

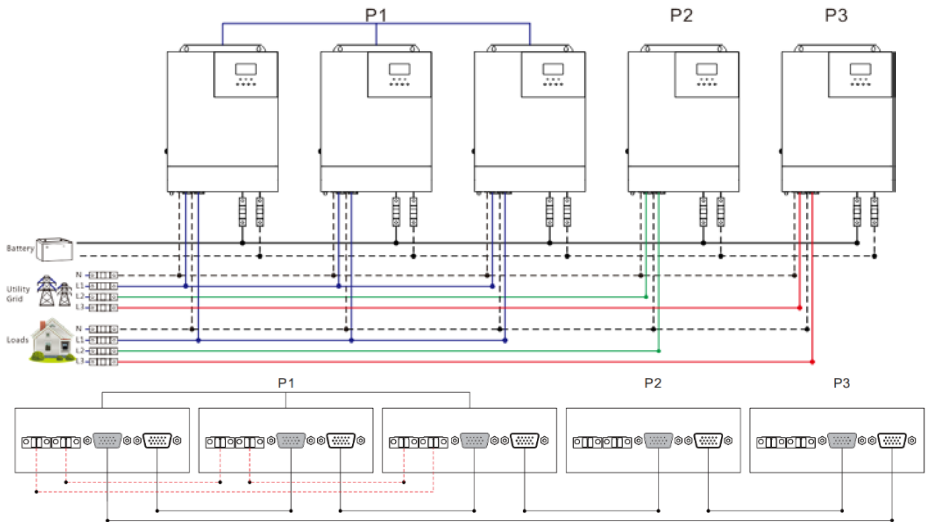

2+2+1 system:

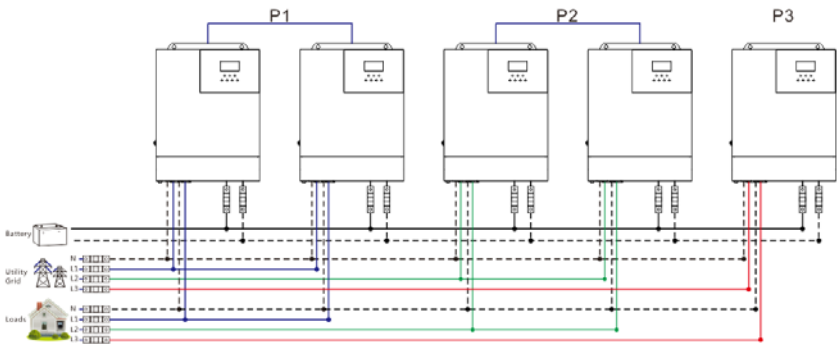

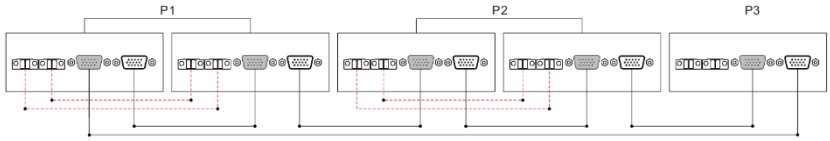

**d) Six all-in-one solar charge inverters of the system connected in three phase:
2+2+2 system:**

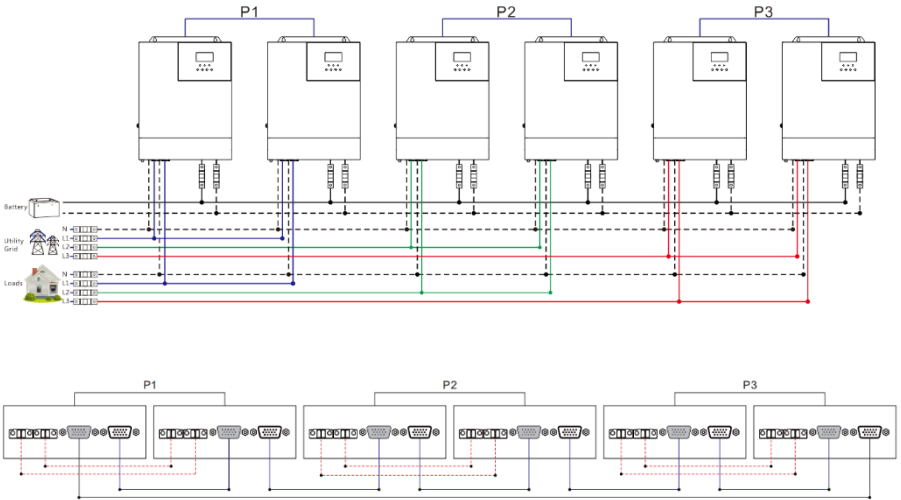

3+2+1 system:

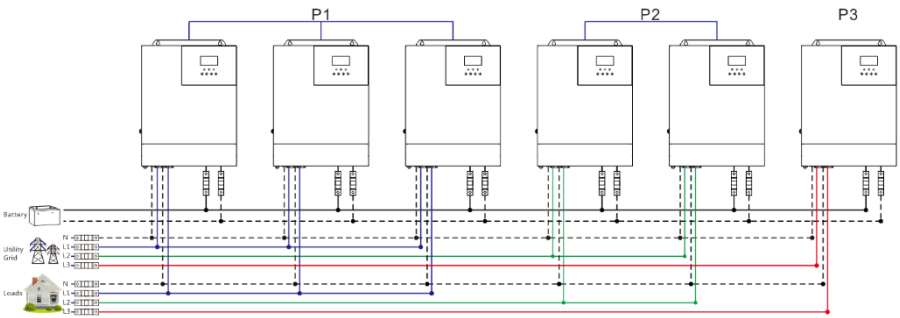

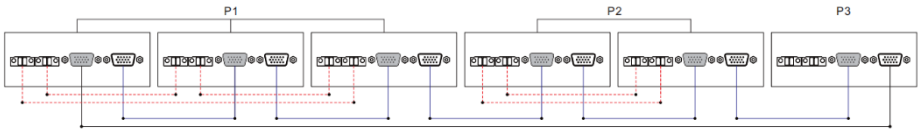

4+1+1 system:

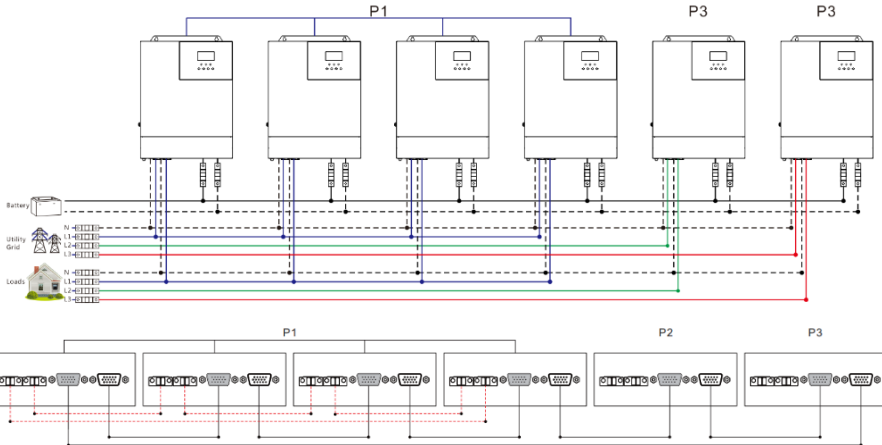

Note:

- 1) Before starting up and running, please check whether the connection was correct to avoid any abnormalities in the system.
- 2) All wiring must be fixed and reliable to avoid wire drop during use.
- 3) When the AC output is wired to the load, it shall be properly wired according to the requirements of the electrical load equipment to avoid damage to the load equipment.
- 4) Settings [38] need to be set consistently or only for the host. When the machine is running, the voltage set by the host shall prevail, and the master will force the rewrite of the other slave machines to keep the same set. Only can be set in the standby mode.
- 5) When using parallel or split phase separation function, the [31] setting items need to be set accordingly.

Parallel Operation in three phase:

The [31] setting item :

All connected P1-phase inverters are set to "3P1" ;

All connected P2-phase inverters are set to "3P2" ;

All connected P3-phase inverters are set to "3P3" ;

When the parameter **[38]** setting item=230 for **S** series model. Phase difference between each live wire is 120 degrees, each line-to-line voltage (L1-L2/L1-L3/L2-L3) is $230 \times 1.732 = 398\text{Vac}$; Each phase voltage is 230Vac (L1-N; L2-N; L3-N).

- 6) When the phase sequence is set **[31]** on the screen, the setting one is turned on to set, and the other machines are turned off. One by one set. Finally, power off and start up again.
- 7) After the system runs, the output voltage is measured correctly, and then the load setting is connected.

3. Operating modes

3.1 Charging mode

- 1) **PV priority:** PV module will charge the battery preferentially, and the battery is charged by the Mains only when the PV system fails. During the day, solar energy is fully used to charge, while at night, it converts to the Mains. This can maintain battery level, and is ideal for areas where the grid is relatively stable and electricity price is relatively high.

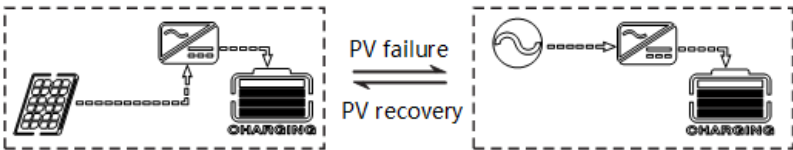

- 2) **Mains priority:** The Mains supply is preferentially used to charge the battery. Only when the Mains fails, the PV charging can be activated.

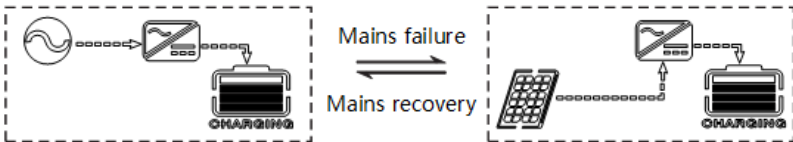

- 3) **Hybrid charging:** PV and mains hybrid charging. PV MPPT charging is a priority, and when PV energy is insufficient, the mains supply supplements. When the PV energy is sufficient again, the mains stops charging. This is the fastest charging mode, suitable for the areas where power grid is unstable, providing sufficient backup power supply at any time.

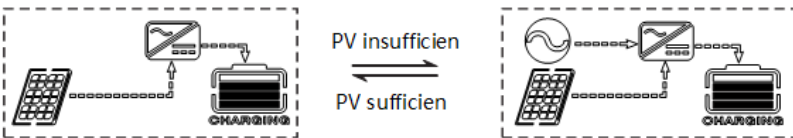

- 4) **Only Solar (Only Solar):** Only PV charging, without Mains charging. This is the most energy-efficient way in which battery is charged only by solar panels, and is usually used in areas with good lighting conditions.

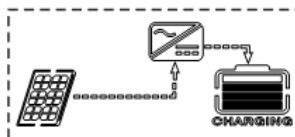

3.2 Output mode

➤ PV priority mode:

Switch to mains supply when the PV charging fails. This mode maximizes the use of solar energy while maintaining battery power, suitable for use in the areas with relatively stable grid. **Power supply priority : Solar—» Utility—» Battery.**

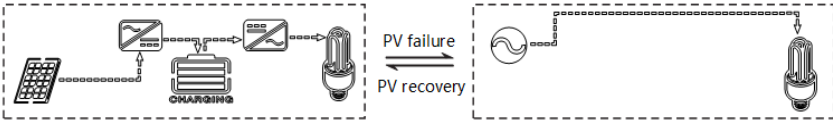

➤ Mains priority mode:

Switch to inverter only when the mains fails (when there was mains power, switch to mains power for charging and power supply). Then, the unit is equivalent to a backup UPS, suitable for areas with unstable grid. Switching does not affect PV charging. **Power supply priority : Utility—» Solar—» Battery.**

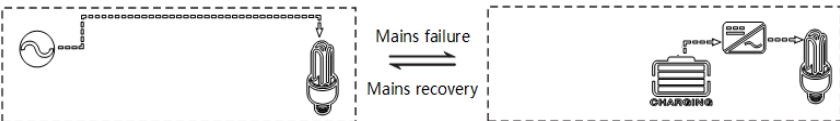

➤ Battery priority mode:

Switch to mains supply only when the battery discharge undervoltage is lower than the set point (item 04). When the charging battery is higher than the set point of (05 setting item), switch to the battery discharge mode. This can cycle the battery charge and discharge. This mode maximizes the use of DC power and is used in the area with stable grid. Switching does not affect PV charging. **Power supply priority : Solar—» Battery—» Utility.**

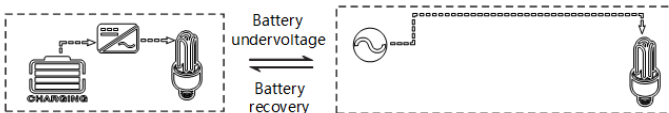

4. LCD screen operating instructions

4.1 Operation and display panel

The operation and display panel is as shown below, including 1 LCD screen, 3 indicators and 4 operation buttons.

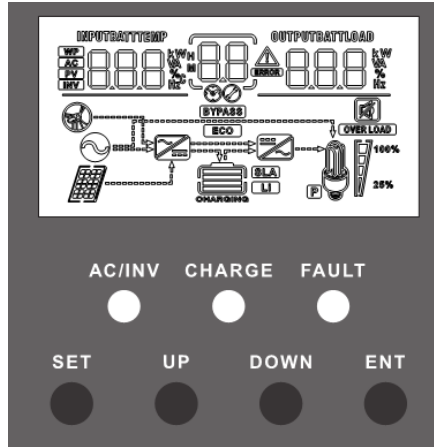

Operation buttons introduction









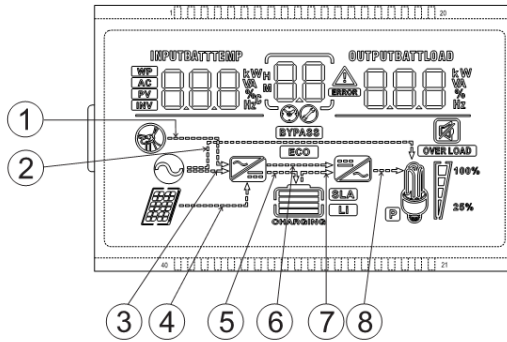











Function buttons	Description
SET	Enter/Exit Settings menu
UP	Previous choice
DOWN	Next choice
ENT	Confirm/Enter Options under the settings menu,













Indicators introduction

Indicators	Colors	Description
AC/INV	Yellow	Steady on: Mains output
		Flash: Inverter output
CHARGE	Green	Flash: Fast charging
		Steady on: Floating charge
FAULT	Red	Flash : Fault state

LCD screen introduction



Icons	Functions	Icons	Functions
	Indicates that the AC input terminal has been connected to the grid		Indicates that the inverter circuit is working
	Indicates that the AC input mode in APL mode (wide voltage range)		Indicates that the machine is in the Mains Bypass mode
	Indicates that the PV input terminal has been connected to the solar panel		Indicates that the AC output is in an overload state
	Indicates that the machine has been connected to the battery:  indicates that the remaining battery is 0%~24%;  indicates that the remaining battery is 25%~49%;  indicates that the remaining battery is 50%~74%;  indicates that the remaining battery is 75%~100%.	 	Indicates the percentage of AC output loads:  indicates that the load percentage is 0%~24%;  indicates that the load percentage is 25%~49%,  indicates that the load percentage is 50%~74%,  indicates that the load percentage is $\geq 75\%$
	Indicates that the battery type of the machine is a lithium battery		Indicates that the buzzer is not enabled
	Indicates that the current battery type of the machine is a lead-acid battery		Indicates that the machine has an alarm

	Indicates that the battery is in charging state		Indicates that the machine is in a fault condition
	Indicates that the AC/PV charging circuit is working		Indicates that the machine is in setup mode
	Indicates that the AC output terminal has an AC voltage output		The parameters displayed in the middle of the screen: 1. In the non-setup mode, the alarm or fault code is displayed. 2. In the setup mode, the currently set parameter item code is displayed.
	In parallel operation, this icon indicates that this inverter is the host, which is only valid in parallel mode.		
Parameters display on the left side of the screen: input parameters			
	Indicates AC input		
	Indicates PV input		
	Indicates inverter circuit		
	This icon is not displayed		
	Display battery voltage, battery charge total current, mains charge power, AC input voltage, AC input frequency, PV input voltage, internal heat sink temperature, software version		
Parameters display on the right side of the screen: Output parameters			
	Indicates output voltage, output current, output active power, output apparent power, battery discharge current, software version; in setup mode, displays the set parameters under the currently set parameter item code		
Arrow display			
①	The arrow is not displayed	⑤	Indicates the charging circuit charging the battery terminal
②	Indicates the grid supplying power to the load	⑥	The arrow is not displayed
③	Indicates grid supplying power to the charging circuit	⑦	Indicates the battery terminal supplying power to the inverter circuit
④	Indicates PV module supplying power to the charging circuit	⑧	Indicates the inverter circuit supplying power to the load

Real-time data viewing method

On the LCD main screen, press the “UP” and “DOWN” buttons to scroll through the real-time data of the machine.

Page	Parameters on the left side of the screen	Parameters in the middle of the screen	Parameters on the right side of the screen
1	INPUT BATT V (Battery input voltage)	Fault code	OUTPUT LOAD V (Output load voltage)
2	BMS BATT V (BMS battery voltage , This parameter is valid when BMS is enabled)		BMS BATT SOC (BMS Percentage of remaining BMS battery capacity This parameter is valid when BMS is enabled)
2	PV TEMP °C (PV charger heatsink temperature)		PV OUTPUT KW (PV output power)
4	PV INPUT V (PV input voltage)		PV OUTPUT A (PV output current)
5	INPUT BATT A (Input battery current)		OUTPUT BATT A (Battery output current)
6	INPUT BATT KW (Battery input power)		OUTPUT BATT KW (Battery output power)
7	AC INPUT Hz (AC input frequency)		AC OUTPUT LOAD Hz (AC output frequency)
8	AC INPUT V (AC input voltage)		AC OUTPUT LOAD A (AC output load current)
9	INPUT V (For maintain)		OUTPUT LOAD KVA (Load apparent power)
10	INV TEMP °C (AC charge or battery discharge heatsink temperature)		INV OUTPUT LOAD KW (Load active power)
11	APP software version		Bootloader software version
12	Model Battery Voltage Rating		Model Output Power Rating
13	Model PV Voltage Rating		Model PV Current Rating
14	RS485 Address Number		Phase Sequence Number

4.2 Setup parameters description

Buttons operation instructions: Press the “SET” button to enter the setup menu and exit the setup menu. After entering the setup menu, the parameter number [00] will flash. At this point, press the “UP” and “DOWN” buttons to select the code of parameter item to be set. Then, press the “ENT” button to enter the parameter editing mode, and the value of the parameter is flashing. Adjust the value of the parameter with the “UP” and “DOWN” buttons. Finally, press the “ENT” button to complete the parameter editing and return to the parameter selection state.

Note: in parallel mode, all machines will synchronize the setting parameters of the host (the machine with "P" is displayed on the display screen) before startup. After startup, the setting parameters of any machine will be synchronized to other machines in the system

Parameter no.	Parameter name	Settings	Description
00	Exit setting menu	[00] ESC	Exit the setup menu
01	Output source priority	[01] SOL	PV priority mode, switching to the Mains when the PV fails or the battery is lower than the set value of parameter [04].
		[01] UTI default	Mains priority mode, switching to inverter only when the mains fails.
		[01] SBU	Battery priority mode. Switch to mains power only when the battery is under voltage or lower than the setting value of parameter [04]; Switch to battery discharge only when the battery is fully charged or higher than the setting value of parameter [05].
02	Output Frequency	[02] 50.0 default	Bypass self-adaptation; when the mains is connected, it automatically adapts to the mains frequency; when the mains is disconnected, the output frequency can be set through this menu. The default output frequency of the 230V machine is 50HZ.
		[02] 60.0	
03	AC Input Voltage Range	[03] APL	Wide mains input voltage range of 230V machine: 90~280V
		[03] UPS default	Narrow mains input voltage range of 230V machine: 170~280V

Parameter no.	Parameter name	Settings	Description
04	Battery Power to Utility Setpoint	[04] 43.6V default	When the parameter [01] =SBU, the battery voltage is lower than the set value, and the output is switched from the inverter to the mains. Setting range: 40V~52V.
05	Utility to Battery Power Setpoint	[05]57.6V default	When the parameter [01] =SBU, the battery voltage is higher than the set value, and the output is switched from the mains to the inverter. Setting range: 48V~60V.
06	Charger source priority	[06] CSO	PV priority charging; only when the PV charging fails, the mains charging is started.
		[06] CUB	Mains priority charging; only when the mains charging fails, the PV charging is started.
		[06] SNU default	PV and Mains hybrid charging; PV charging is a priority, and when the PV energy is insufficient, the Mains charging supplements. When the PV energy is sufficient, the Mains charging stops. Note: Only when the Mains bypass output is loaded, the PV charging and the mains charging can work at the same time. When the inverter works, only the PV charging can be started.
		[06] OSO	Only PV charging, with the Mains charging not activated.
07	Max charger current	[07] 60A default	Max charger current (AC charger+PV charger). S series model : setting range 0~80A;
08	Battery Type	[08] USE	User-defined; all battery parameters can be set.
		[08] SLd	Sealed lead-acid battery; constant-voltage charge voltage: 57.6V, floating charge voltage: 55.2V.
		[08] FLd	Vented lead-acid battery; constant-voltage charge voltage: 58.4V, floating charge voltage: 55.2V.
		[08] GEL default	Colloidal lead-acid battery; constant-voltage charge voltage: 56.8V, floating charge voltage: 55.2V.

Parameter no.	Parameter name	Settings	Description
		[08] L14/L15/L16	LFP battery L14/L15/L16, corresponding to 14strings ,15 strings and 16 strings of LFP battery; for 16 strings, default constant-voltage charge voltage is 56.8V; for 15 strings, default constant-voltage charge voltage is 53.2V; for 14 strings, default constant-voltage charge voltage is 49.2V; allow adjustable.
		[08] N13/N14	Ternary lithium battery; which is adjustable.
09	Battery boost charge voltage	[09] 56.8V default	Boost charge voltage setting; the setting range is 48V~58.4V, with step of 0.4V; it is valid for user-defined battery and lithium battery.
10	Battery boost charge time	[10] 120 default	Boost charge maximum time setting, which means the maximum charging time to reach the set voltage of parameter [09] during constant-voltage charging. The setting range is 5min~900min, with a step of 5 minutes. It is valid for user-defined battery and lithium battery.
11	Battery floating charge voltage	[11] 55.2V default	Floating charge voltage, setting range: 48V~58.4V, step: 0.4V, valid when battery type is user-defined.
12	Battery over discharge voltage (delay off)	[12] 42V default	Over-discharge voltage; when the battery voltage is lower than this judgment point, delay the time set by parameter [13] and turn off inverter output. Setting range is 40V~48V, with a step of 0.4V. It is valid for user-defined battery and lithium battery.
13	Battery over discharge delay time	[13] 5S default	Over-discharge delay time; when the battery voltage is lower than the parameter [12], the inverter output will be turned off after the time set by this parameter is delayed. The setting range is 5S~55S, with a step of 5S. It is valid for user-defined battery and lithium battery.
14	Battery under voltage alarm	[14] 44V default	Battery undervoltage alarm point; when the battery voltage is lower than the point, an undervoltage alarm is given, and the output is not turned off; the setting range is 40V~52V,

Parameter no.	Parameter name	Settings	Description
			with a step of 0.4V. It is valid for user-defined battery and lithium battery.
15	Battery discharge limit voltage	[15] 40V default	Battery discharge limit voltage; when the battery voltage is lower than the point, the output is turned off immediately; the setting range is 40V~52V, with a step of 0.4V. It is valid for user-defined battery and lithium battery.
16	Battery equalization enable	[16] DIS	Equalizing charge is disabled
		[16] ENA default	Equalizing charge is enabled, only valid for vented lead-acid battery and sealed lead-acid battery
17	Battery equalization voltage	[17] 58.4V default	Equalizing charge voltage; setting range: 48V~58.4V, with a step of 0.4V; valid for vented lead-acid battery and sealed lead-acid battery
18	Battery equalized time	[18] 120 default	Equalizing charge time; setting range: 5min~900min, with a step of 5 minutes; valid for vented lead-acid battery and sealed lead-acid battery
19	Battery equalized time out	[19] 120 default	Equalizing charge delay; setting range: 5min~900min, with a step of 5 minutes; valid for vented lead-acid battery and sealed lead-acid battery
20	Battery equalization interval	[20] 30 default	Equalizing charge derating time, 0~30days, with a step of 1 day; valid for vented lead-acid battery and sealed lead-acid battery
21	Battery equalization immediately	[21] DIS default	Stop equalizing charge immediately.
		[21] ENA	Start equalizing charge immediately.
22	Power saving mode	[22] DIS default	Power saving mode disabled.
		[22] ENA	After the power saving mode is enabled, if the load is null or less than 50W, the inverter output is turned off after a delay for a certain period of time. When the load is more than 50W, the inverter automatic restart.

Parameter no.	Parameter name	Settings	Description
23	Restart when over load	[23] DIS	Automatic restart when overload is disabled. If an overload occurs and the output is turned off, the machine will not restart.
		[23] ENA default	Automatic restart when overload is enabled. If an overload occurs and the output is turned off, the machine will restart after a delay of 3 minutes. After it reaches 5 cumulative times, the machine will not restart.
24	Restart when over temperature	[24] DIS	Automatic restart when over temperature is disabled. If an over-temperature shutdown occurs, machine will not restart to turn the output on.
		[24] ENA default	Automatic restart when over temperature is enabled. If an over-temperature shutdown occurs, the machine will restart when the temperature drops.
25	Alarm enable	[25] DIS	Alarm is disabled
		[25] ENA default	Alarm is enabled
26	Beeps while primary source is interrupted	[26] DIS	Alarm beep is disabled when the status of the main input source changes
		[26] ENA default	Alarm beep is enabled when the status of the main input source changes
27	Bypass output when over load	[27] DIS	It is disabled to automatically switch to the Mains when the inverter is overloaded.
		[27] ENA default	It is enabled to automatically switch to the Mains when the inverter is overloaded.
28	Max AC charger current	[28] 60A default	S series model : Max AC charger current. Setting range: 0~60A ; 60A default .
29	Split Phase	[29] DIS default	Supply for industrial frequency transformer (disabled)
		[29] ENA	Supply for industrial frequency transformer (enabled)
30	Model ID setting	[30] 1 default	RS485 address number. Parallel mode needs to be set in the range of 1-6. When the power is first turned on, it will be automatically distributed

Parameter no.	Parameter name	Settings	Description
31	AC output mode (can be set in the standby mode only)	[31] SIG default	When single inverter is used, the default is SIG mode.
		[31] PAL	In parallel operation with single phase. Please refer to 2.4 Wiring Diagram.
		[31] 3P1/3P2/3P3	In split phase operation with three phase. At least one inverter is required for each phase. Please refer to 2.4 Wiring Diagram.
		When the parameter [38] setting item=230 . All connected P1-phase inverters are set to "3P1" ; All connected P2-phase inverters are set to "3P2" ; All connected P3-phase inverters are set to "3P3" ; AC output line voltage difference is 120 degrees (L1-L2/L1-L3/L2-L3), each line voltage is $230 \times 1.732 = 398\text{Vac}$; Each phase voltage is 230Vac (L1-N; L2-N; L3-N).	
32	RS485-1 communication	[32]SLA default	RS485-2 port for PC or telecommunication control.
		[32]BMS	RS485-2 port for BMS communication.
33	Battery BMS communication	When the parameter [32] setting item = BMS , you can choose to match the battery manufacturer's BMS protocol to communicate with BMS for the lithium battery protection.	
		PAC=PACE , RDA=Ritar , AOG=ALLGRAND BATTERY , OLT=OLITER , HWD=SUNWODA , DAQ=DAKING , WOW=SRNE , PYL=PYLONTECH , UOL=WEILAN	
35	Battery undervoltage recovery point	[35] 52V default	When the battery voltage is under voltage, the battery voltage needs to recover more than this set value before the inverter starts the output
36	Max PV charger current	[36] 80A default	Max PV charger current. Setting range: 0~80A
37	Battery fully charged recovery point	[37] 52V default	After the battery is fully charged, it needs to be lower than this set voltage before it can be recharged
38	AC output voltage setting (only can be set in the standby mode)	[38] 230Vac default	230V default Allow to set to 200/208/220/230/240Vac. The rated output power will be reduced= (Power Rate)*(Vset/230)

4.3 Battery type parameters

For Lead-acid Battery :

Battery type Parameters	Sealed lead acid battery (SLD)	Colloidal lead acid battery (GEL)	Vented lead acid battery (FLD)	User-defined (User)
Overvoltage disconnection voltage	60V	60V	60V	36 ~ 60V (Adjustable)
Battery fully charged recovery point(setup item 37)	52V (Adjustable)	52V (Adjustable)	52V (Adjustable)	52V (Adjustable)
Equalizing charge voltage	58.4V	56.8V	59.2V	36 ~ 60V (Adjustable)
Boost charge voltage	57.6V	56.8V	58.4V	36 ~ 60V (Adjustable)
Floating charge voltage	55.2V	55.2V	55.2V	36 ~ 60V (Adjustable)
Undervoltage alarm voltage(01 fault)	44V	44V	44V	36 ~ 60V (Adjustable)
Undervoltage alarm voltage recovery point(01 fault)	Undervoltage alarm voltage+0.8V			
Low voltage disconnection voltage(04 fault)	42V	42V	42V	36 ~ 60V (Adjustable)
Low voltage disconnection voltage recovery point (04 fault)(setup item 35)	52V (Adjustable)	52V (Adjustable)	52V (Adjustable)	52V (Adjustable)
Discharge limit voltage	40V	40V	40V	36 ~ 60V (Adjustable)
Over-discharge delay time	5s	5s	5s	1 ~ 30s (Adjustable)
Equalizing charge duration	120 minutes	-	120 minutes	0 ~ 600 minutes (Adjustable)
Equalizing charge interval	30 days	-	30 days	0 ~ 250 days (Adjustable)
Boost charge duration	120 minutes	120 minutes	120 minutes	10 ~ 600 minutes (Adjustable)

For Lithium Battery :

Battery type Parameters	Ternary lithium battery (N13)	Ternary lithium battery (N14)	LFP battery (L16)	LFP battery (L15)	LFP battery (L14)
Overvoltage disconnection voltage	60V	60V	60V	60V	60V
Battery fully charged recovery point(setup item 37)	50.4V (Adjustable)	54.8V (Adjustable)	53.6V (Adjustable)	50.4V (Adjustable)	47.6V (Adjustable)
Equalizing charge voltage	53.2V (Adjustable)	57.6V (Adjustable)	56.8V (Adjustable)	53.2V (Adjustable)	49.2V (Adjustable)
Boost charge voltage	53.2V (Adjustable)	57.6V (Adjustable)	56.8V (Adjustable)	53.2V (Adjustable)	49.2V (Adjustable)
Floating charge voltage	53.2V (Adjustable)	57.6V (Adjustable)	56.8V (Adjustable)	53.2V (Adjustable)	49.2 (Adjustable)
Undervoltage alarm voltage(01 fault)	43.6V (Adjustable)	46.8V (Adjustable)	49.6V (Adjustable)	46.4V (Adjustable)	43.2V (Adjustable)
Undervoltage alarm voltage recovery point(01 fault)	Undervoltage alarm voltage+0.8V				
Low voltage disconnection voltage(04 fault)	38.8V (Adjustable)	42V (Adjustable)	48.8V (Adjustable)	45.6V (Adjustable)	42V (Adjustable)
Low voltage disconnection voltage recovery point (04 fault)(setup item 35)	46V (Adjustable)	49.6V (Adjustable)	52.8V (Adjustable)	49.6V (Adjustable)	46V (Adjustable)
Discharge limit voltage	36.4V	39.2V	46.4V	43.6V	40.8V
Over-discharge delay time	30s (Adjustable)	30s (Adjustable)	30s (Adjustable)	30s (Adjustable)	30s (Adjustable)
Boost charge duration	120 minutes (Adjustable)	120 minutes (Adjustable)	120 minutes (Adjustable)	120 minutes (Adjustable)	120 minutes (Adjustable)

5. Other functions

5.1 Dry contact

Working principle: This dry contact can control the ON/OFF of the diesel generator to charge the battery. ① Normally, the terminals are that the NC-N point is closed and the NO-N point is open; ② When the battery voltage reaches the low voltage disconnection point, the relay coil is energized, and the terminals turn to that the NO-N point is closed while NC-N point is open. At this point, NO-N point can drive resistive loads: 125VAC/1A, 230VAC/1A, 30VDC/1A.

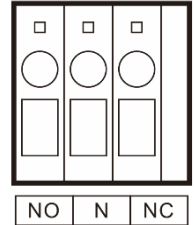

5.2 RS485 communication port

This port is an RS485 communication port which comes with two functions:

- ① RS485-2 allows direct communication with the optional host computer developed by our company through this port, and enables monitoring of the equipment running status and setting of some parameters on the computer;
- ② RS485-1/RS485-2 also allows direct connection with the optional RS485 to WiFi/GPRS communication module developed by our company through this port. After the module is selected, you can connect the all-in-one solar charge inverter through the mobile phone APP, on which you can view the operating parameters and status of the device.

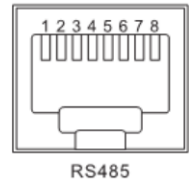

As shown in the figure:

RS485-1: Pin 1 is 5V power supply, Pin 2 is GND, Pin 7 is RS485-A1, and Pin 8 is RS485-B1;

RS485-2: Pin 1 is 5V power supply, Pin 2 is GND, Pin 7 is RS485-A2, and Pin 8 is RS485-B2;

5.3 USB communication port

This is a USB communication port, which can be used for USB communication with the optional PC host software. To use this port, you should install the corresponding "USB to serial chip CH340T driver" in the computer.

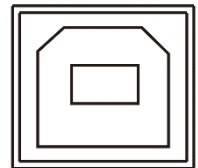

5.4 Parallel communication function (parallel operation only)

- a) This port is used for parallel communication, through which the parallel modules can communicate with each other.
- b) Each inverter has two DB15 ports, one for the male connector and the other for the female connector.
- c) When connecting, make sure to connect the male connector of the inverter with the female connector of the inverter to be paralleled, or connect the female connector of the inverter to the male connector of the inverter to be paralleled.
- d) Do not connect the male connector of the inverter to its female connector.

Female connector

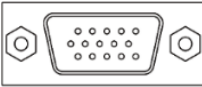

Male connector

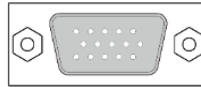

5.5 Current sharing detection function (parallel operation only)

- a) This port is used for current sharing detection, through which the current sharing of the parallel modules can be detected (parallel operation only).
- b) Each inverter has two current sharing detection ports, which are connected in parallel. When it is connected to other models to be paralleled, either port can be connected for convenience. There is no special mandatory wiring requirements.

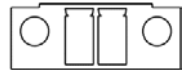

6. Protection

6.1 Protections provided

No.	Protections	Description
1	PV current/power limiting protection	When charging current or power of the PV array configured exceeds the PV rated, it will charge at the rated.
2	PV night reverse-current protection	At night, the battery is prevented from discharging through the PV module because the battery voltage is greater than the voltage of PV module.
3	Mains input over voltage protection	When the mains voltage exceeds 280V, the mains charging will be stopped and switched to the inverter mode.
4	Mains input under voltage protection	When the mains voltage is lower than 170V (230V model /UPS mode), the mains charging will be stopped and switched to the inverter mode.
5	Battery over voltage protection	When the battery voltage reaches the overvoltage disconnection point, the PV and the mains will be automatically stopped to charge the battery to prevent the battery from being overcharged and damaged.
6	Battery low voltage protection	When the battery voltage reaches the low voltage disconnection point, the battery discharging will be automatically stopped to prevent the battery from being over-discharged and damaged.
7	Load output short circuit protection	When a short-circuit fault occurs at the load output terminal, the AC output is immediately turned off and turned on again after 1 second.
8	Heat sink over temperature protection	When the internal temperature is too high, the all-in-one machine will stop charging and discharging; when the temperature returns to normal, charging and discharging will resume.
9	Overload protection	Output again 3 minutes after an overload protection, and turn the output off after 5 consecutive times of overload protection until the machine is re-powered. For the specific overload level and duration, refer to the technical parameters table in the manual.
10	PV reverse polarity protection	When the PV polarity is reversed, the machine will not be damaged.

11	AC reverse protection	Prevent battery inverter AC current from being reversely input to Bypass.
12	Bypass over current protection	Built-in AC input overcurrent protection circuit breaker.
13	Battery input over current protection	When the discharge output current of the battery is greater than the maximum value and lasts for 1 minute, the AC input would switched to load.
14	Battery input protection	When the battery is reversely connected or the inverter is short-circuited, the battery input fuse in the inverter will blow out to prevent the battery from being damaged or causing a fire.
15	Charge short protection	When the external battery port is short-circuited in the PV or AC charging state, the inverter will protect and stop the output current.
16	CAN communication loss protection	In parallel operation, an alarm will be given when CAN communication is lost.
17	Parallel connection error protection	In parallel operation, the equipment will be protected when the parallel line is lost.
18	Parallel battery voltage difference protection	In parallel operation, the equipment will be protected when the battery connection is inconsistent and the battery voltage is greatly different from that detected by the host.
19	Parallel AC voltage difference protection	In parallel operation, the equipment will be protected when the AC IN input connection is inconsistent.
20	Parallel current sharing fault protection	In parallel operation, the running equipment will be protected when the load difference of each inverter is large due to improper connection of current sharing line or device damage.
21	Synchronization signal fault protection	The equipment will be protected when there is a fault in the guidance signal between parallel buses, causing inconsistent behavior of each inverter.

6.2 Fault code

Fault code	Fault name	Whether it affects the output or not	Description
[01]	BatVoltLow	NO	Battery undervoltage alarm
[02]	BatOverCurrSw	Yes	Battery discharge average current overcurrent software protection
[03]	BatOpen	Yes	Battery not-connected alarm
[04]	BatLowEod	Yes	Battery undervoltage stop discharge alarm
[05]	BatOverCurrHw	Yes	Battery overcurrent hardware protection
[06]	BatOverVolt	Yes	Charging overvoltage protection
[07]	BusOverVoltHw	Yes	Bus overvoltage hardware protection
[08]	BusOverVoltSw	Yes	Bus overvoltage software protection
[09]	PvVoltHigh	No	PV overvoltage protection
[10]	PvBoostOCSw	No	Boost overcurrent software protection

【11】	PvBoostOCHw	No	Boost overcurrent hardware protection
【12】	bLineLoss	No	Mains power down
【13】	OverloadBypass	Yes	Bypass overload protection
【14】	OverloadInverter	Yes	Inverter overload protection
【15】	AcOverCurrHw	Yes	Inverter overcurrent hardware protection
【17】	InvShort	Yes	Inverter short circuit protection
【19】	OverTemperMppt	No	Buck heat sink over temperature protection
【20】	OverTemperInv	Yes	Inverter heat sink over temperature protection
【21】	FanFail	Yes	Fan failure
【22】	EEPROM	Yes	Memory failure
【23】	ModelNumErr	Yes	Model setting error
【26】	RlyShort	Yes	Inverted AC Output Backfills to Bypass AC Input

【29】	BusVoltLow	Yes	Internal battery boost circuit failure
【30】	BatCapacityLow1	No	Alarm given when battery capacity rate is lower than 10% (setting BMS to enable validity)
【31】	BatCapacityLow2	No	Alarm given when battery capacity rate is lower than 5% (setting BMS to enable validity)
【32】	BatCapacityLowStop	Yes	Inverter stops when battery capacity is low (setting BMS to enable validity)
【34】	CanCommFault	Yes	CAN communication fault in parallel operation
【35】	ParaAddrErr	Yes	Parallel ID setting error
【36】	-	-	-
【37】	ParaShareCurrErr	Yes	Parallel current sharing fault
【38】	ParaBattVoltDiff	Yes	Large battery voltage difference in parallel mode
【39】	ParaAcSrcDiff	Yes	Inconsistent AC input source in parallel mode
【40】	ParaHwSynErr	Yes	Hardware synchronization signal error in parallel mode
【41】	InvDcVoltErr	Yes	Inverter DC voltage error

[42]	SysFwVersionDiff	Yes	Inconsistent system firmware version in parallel mode
[43]	ParaLineContErr	Yes	Parallel line connection error in parallel mode
[44]	Serial number error	YES	If the serial number is not set by omission in production, please contact the manufacturer to set it
[45]	Error setting of splitphase mode	YES	[31] Settings item setting error
[58]	BMS communication error	NO	Check whether the communication line is connected correctly and whether [33] is set to the corresponding lithium battery communication protocol
[59]	BMS alarm	NO	Check the BMS fault type and troubleshoot battery problems
[60]	BMS battery low temperature alarm	NO	BMS alarm battery low temperature
[61]	BMS battery over temperature alarm	NO	BMS alarm battery over temperature
[62]	BMS battery over current alarm	NO	BMS alarm battery over current
[63]	BMS low battery talarm	NO	BMS alarm low battery
[64]	BMS battery over voltage alarm	NO	BMS alarm battery over voltage

6.3 Handling measures for part of faults

Fault code	Faults	Remedy
Display	No display on the screen	Check if the battery the PV air switch has been closed; if the switch is in the "ON" state; press any button on the screen to exit the screen sleep mode.
[06]	Battery overvoltage protection	Measure if the battery voltage exceeds rated, and turn off the PV array air switch and Mains air switch.
[01] [04]	Battery undervoltage protection	Charge the battery until it returns to the low voltage disconnection recovery voltage.
[21]	Fan failure	Check if the fan is not turning or blocked by foreign object.
[19] [20]	Heat sink over temperature protection	When the temperature of the device is cooled below the recovery temperature, normal charge and discharge control is resumed.
[13] [14]	Bypass overload protection, inverter overload protection	① Reduce the use of power equipment; ② Restart the unit to resume load output.
[17]	Inverter short circuit protection	① Check the load connection carefully and clear the short-circuit fault points; ② Re-power up to resume load output.
[09]	PV overvoltage	Use a multimeter to check if the PV input voltage exceeds the maximum allowable input voltage rated.
[03]	Battery disconnected alarm	Check if the battery is not connected or if the battery circuit breaker is not closed.
[40] [43]	Parallel connection fault	Check whether the parallel line is not connected well, such as loose or wrong connection.
[35]	Parallel ID setting error	Check whether the setting of parallel ID number is repeated.
[37]	Parallel current sharing fault	Check whether the parallel current sharing line is not connected well, such as loose or wrong connection.
[39]	Inconsistent AC input source in parallel mode	Check whether the parallel AC inputs are from the same input interface.
[42]	Inconsistent system firmware version in parallel mode	Check whether the software version of each inverter is consistent.

7.Troubleshooting

- **In order to maintain the best long-term performance, it is recommended to conduct following checks twice a year.**
 1. Make sure that the airflow around the unit is not blocked and remove any dirt or debris from the heat sink.
 2. Check that all exposed wires are damaged by exposure to sunlight, friction with other objects around them, dryness, bite by insects or rodents, etc., and the wires shall be repaired or replaced if necessary.
 3. Verify for the consistency of indication and display with the operation of the device. Please pay attention to the display of any faults or errors, and take corrective actions if necessary.
 4. Check all wiring terminals for corrosion, insulation damage, signs of high temperature or burning/discoloration, and tighten the screws.
 5. Check for dirt, nesting insects and corrosion, and clean up as required.
 6. If the arrester has failed, replace in time to prevent lightning damage to the unit or even other equipment of the user.

Warning: Danger of electric shock! When doing the above operations, make sure that all power supplies of the all-in-one machine have been disconnected, and all capacitors have been discharged, and then check or operate accordingly!

- **The company does not assume any liability for damage caused by:**
 - ① Improper use or use in improper site.
 - ② Open circuit voltage of the PV module exceeds the maximum allowable voltage rated.
 - ③ Temperature in the operating environment exceeds the limited operating temperature range.
 - ④ Disassemble and repair the all-in-one solar charge inverter without permission.
 - ⑤ Force majeure: Damage that occurs in transportation or handling of the all-in-one solar charge inverter.

8. Technical parameters

Models	HFP4850S80-H
Parallel mode	
Permitted parallel number	1~6
AC mode	
Rated input voltage	220/230Vac
Input voltage range	(170Vac~280Vac) $\pm 2\%$ (90Vac-280Vac) $\pm 2\%$
Frequency	50Hz/ 60Hz (Auto detection)
Frequency Range	47 \pm 0.3Hz ~ 55 \pm 0.3Hz (50Hz); 57 \pm 0.3Hz ~ 65 \pm 0.3Hz (60Hz);
Overload/short circuit protection	Circuit breaker
Efficiency	>95%
Conversion time (bypass and inverter)	10ms (typical)
AC reverse protection	Available
Maximum bypass overload current	40A
Inverter mode	
Output voltage waveform	Pure sine wave
Rated output power (VA)	5000
Rated output power (W)	5000
Power factor	1
Rated output voltage (Vac)	230Vac
Output voltage error	$\pm 5\%$
Output frequency range (Hz)	50Hz \pm 0.3Hz 60Hz \pm 0.3Hz
Maximum Efficiency	>92%
Overload protection	(102% < load <125%) $\pm 10\%$: report error and turn off the output after 5 minutes; (125% < load < 150%) $\pm 10\%$: report error and turn off the output after 10 seconds; Load >150% $\pm 10\%$: report error and turn off the output after 5 seconds
Peak power	10000VA

Loaded motor capability	4HP
Rated battery input voltage	48V (Minimum starting voltage 44V)
Battery voltage range	Undervoltage alarm/shutdown voltage/overvoltage alarm /overvoltage recovery... settable on LCD screen)
Power saving mode self-consumption	Load \leq 50W
AC charging	
Battery type	Lead acid or lithium battery
Maximum charge current(can be set)	0-60A
Charge current error	\pm 3A _{dc}
Charge voltage range	40 –58V _{dc}
Short circuit protection	Circuit breaker and blown fuse
Circuit breaker specifications	40A
Overcharge protection	Alarm and turn off charging after 1 minute
PV charging	
Maximum PV open circuit voltage	500V _{dc}
PV operating voltage range	120-500V _{dc}
MPPT voltage range	120-450V _{dc}
Battery voltage range	40-60V _{dc}
Maximum PV input power	5500W
Maximum PV input current	22A
PV charging current range (can be set)	0-80A
Charging short circuit protection	Blown fuse
Wiring protection	Reverse polarity protection
Hybrid charging Max charger current specifications (AC charger+ PV charger)	
Max charger current(can be set)	0-80A
Certified specifications	
Certification	CE(IEC62109-1) / CETL(UL 1741 C22.2 NO.107.1) /FCC/SAA

EMC certification level	EN61000
Operating temperature range	-10°C to 55°C
Storage temperature range	-25°C ~ 60°C
Humidity range	5% to 95% (Conformal coating protection)
Noise	≤60dB
Heat dissipation	Forced air cooling, variable speed of fan
Communication interface	USB/RS485(WiFi/GPRS)/Dry contact control
Dimension (L*W*D)	426mm*322mm*124mm
Weight	10.5kg



- **Google browser**,scan the QR code to download the APP
- In the Google Play Store, search for "**SmartESS**" to download and install